



ELIKA[®]
by **MARZOCCHI**

The new Marzocchi
Low - noise and Low - ripple
gear pump
ELI3 series up to 87 cm³/rev



ELIKA, Marzocchi's new proposal for the gear pump market, is a perfect fit for all those applications that require low noise levels. The use of ELIKA gear pump eliminates adverse noise effects on humans and on the surrounding environment. The ELIKA reduces the noise level by an average of 15 dBA compared with a conventional external gear pump. ELIKA is a patented product. Marzocchi extends the ELIKA family introducing the new ELI3 group, with displacements from 20.4 to 87.1 cm³/rev.

ELI3 includes pumps with displacements from 20.4 to 87.1 cm³/rev; perfectly interchangeable with our standard gear pumps in the ALP3 and GHP3 series. The maximum operating pressures are similar to those of the GHP series and extend up to 300 bar. The helical gears ensure the continuity of the motion despite the low number of teeth. The low number of teeth reduces the fundamental frequencies of the pump noise, producing a more pleasant sound. The particular shape of the profile without encapsulation significantly reduces pressure-oscillations and vibrations produced by the pump and transmitted to the other components, reducing the noise of the hydraulic system. Axial forces induced by the helical teeth are optimally balanced in all operating conditions by the axial compensation system integrated in the pump cover. Specific compensation areas in the flange and cover, insulated by special gaskets reinforced with anti extrusion, allow for fully free axial and radial movement of the bushings. In this way, internal leakage is dramatically reduced, ensuring very good volumetric and mechanical pump performances, as well as proper lubrication of pump's moving parts. ELI3 pumps are available in both unidirectional clockwise or counter clockwise rotation. The particular shape of the Elika profile patented by Marzocchi Pompe, eliminates the phenomenon of encapsulation typical of normal gear pumps, deleting the source of the main cause of noise and vibrations.

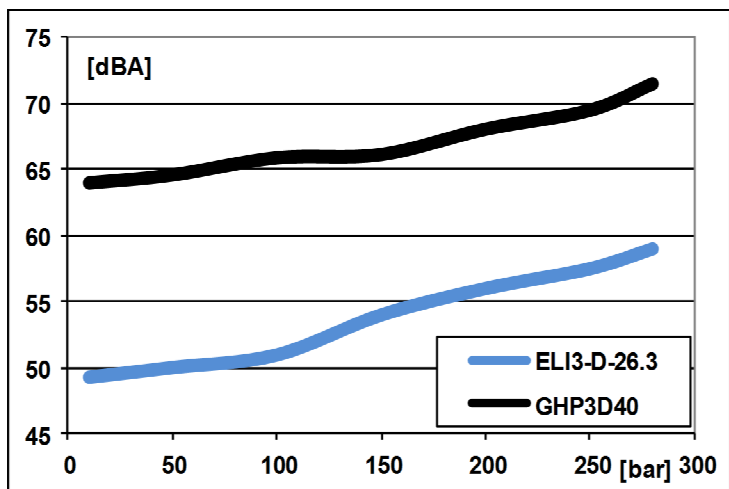

Noise pump comparison [dBA] Marzocchi GHP3 – ELIKA ELI 3, 1500 rpm, same displacement 26.3 cm³/rev, pressure 200 bar.

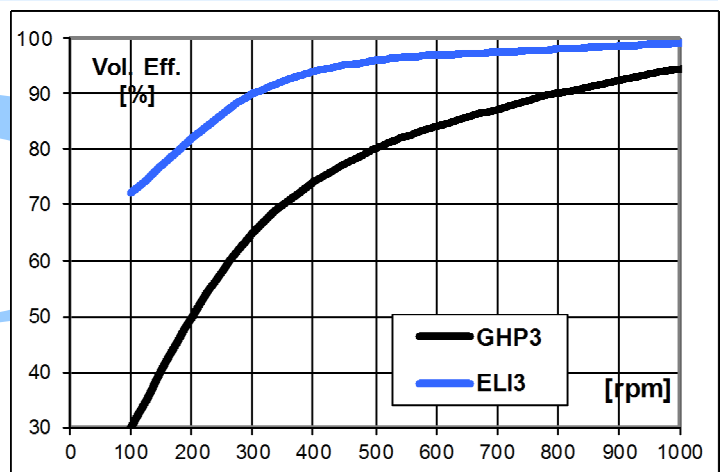

Comparison of volumetric efficiency at low rotation speed, Pm=200 bar Marzocchi GHP 3 – ELIKA ELI 3, displacement 26.3 cm³/rev.

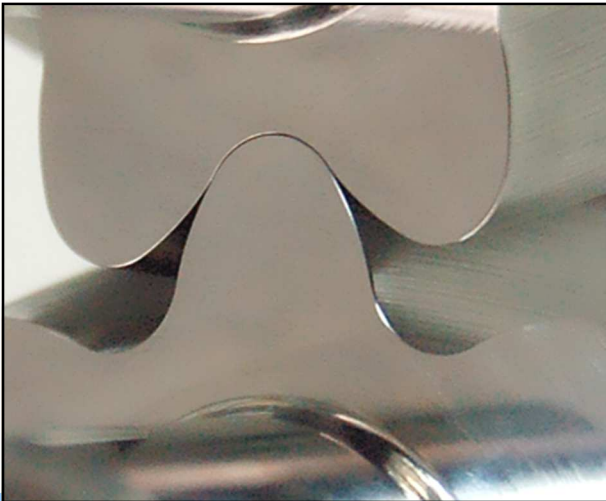

The pump structure minimizes the internal leakage, maximizing the volumetric efficiency under all conditions. This feature makes the Elika pump suitable for work operations with low speed and high pressure. Internal leakage, virtually eliminated in the Elika pumps, can overheat the pump's components. Comparing the characteristics of the Elika pump with other kind of volumetric pumps, it is possible to see that they have a very high range of applications in terms of: the rotation speed, work pressure and viscosity range.

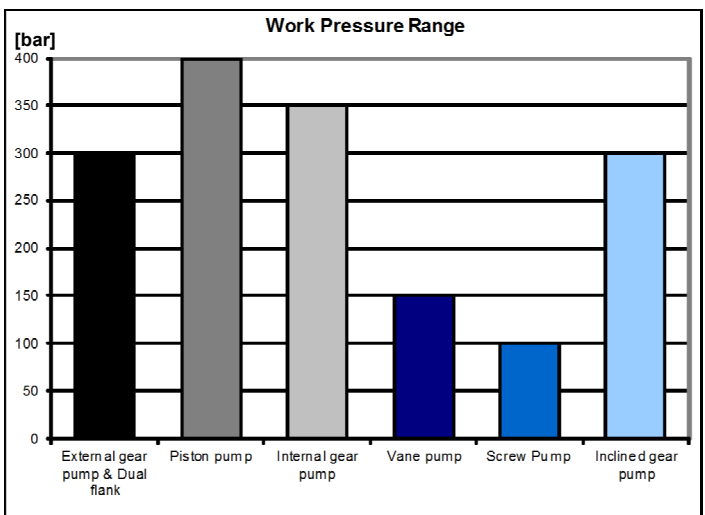
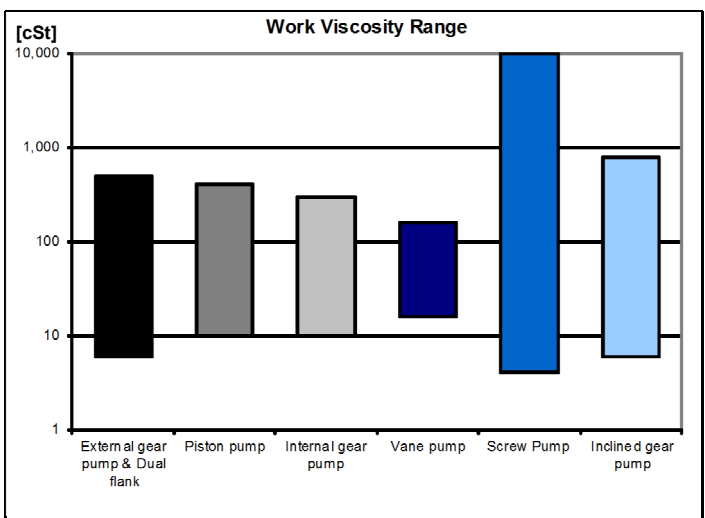
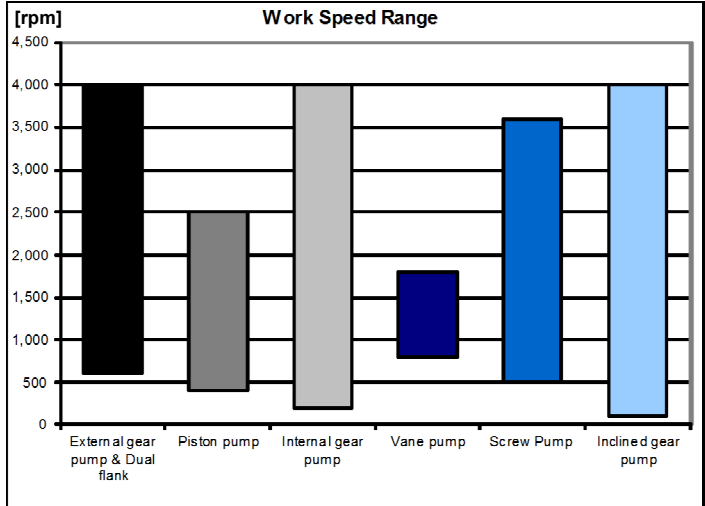

Above: comparison between the different fields of use of other kinds of volumetric pumps.

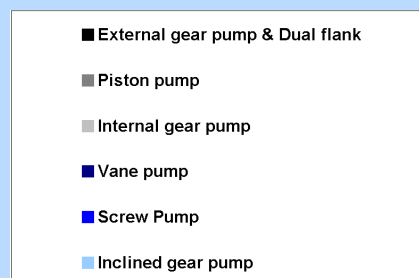

The very low noise level generated by the ELIKA pumps makes this product particularly suitable for those applications where screw pumps, vane pumps or internal gear pumps are generally used. The simple construction, small size and high performances of ELIKA make this new product very competitive.

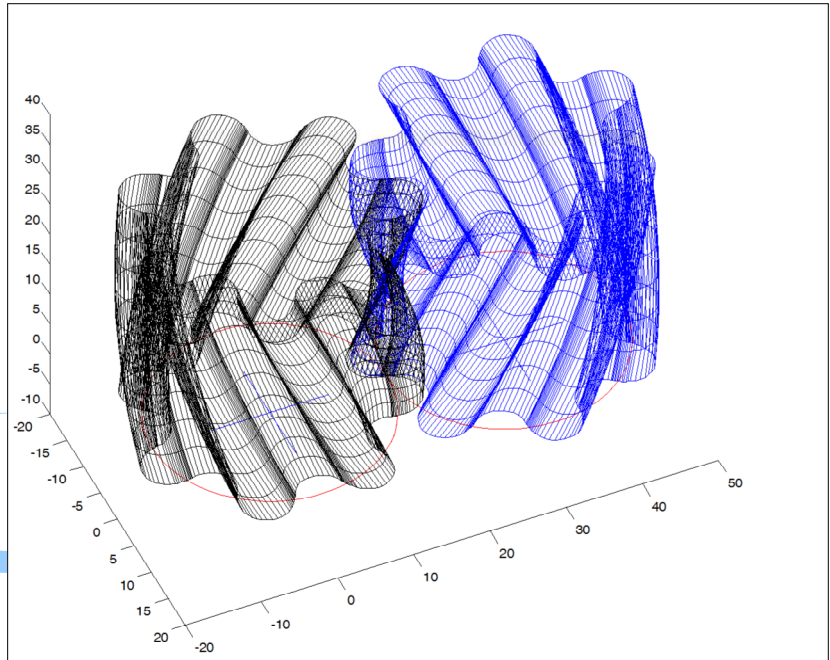

Noise comparison between:
standard external gear pump,
dual flank gear pump,
internal gear pump,
vane pump,
ELIKA pump,
pressure = 200 bar.

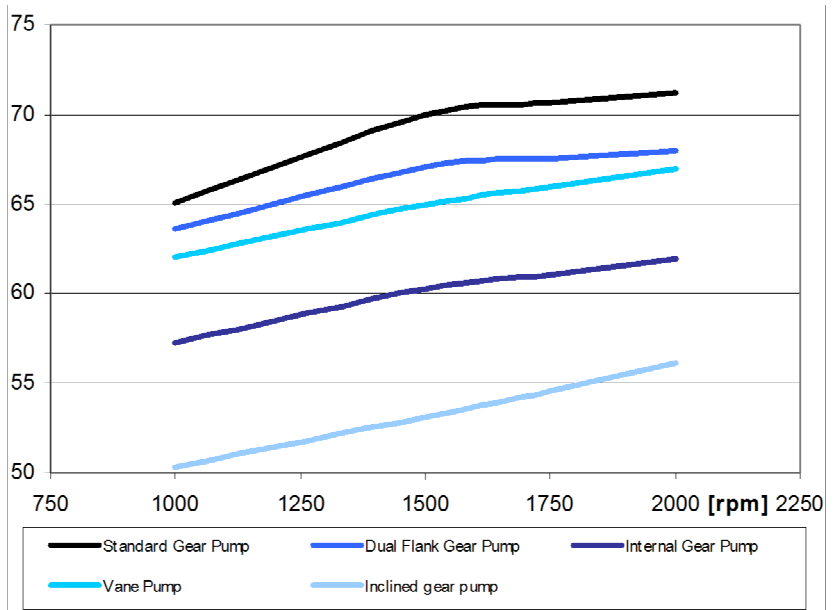

The low pulsation reduces the induced vibration in the machines. The lower frequency of the ELIKA pump produces a more pleasant sound. Pressure pulsation comparison between:
standard external gear pump,
dual flank gear pump,
ELIKA pump. Pressure = 200 bar,
rotation speed = 1500 rpm.

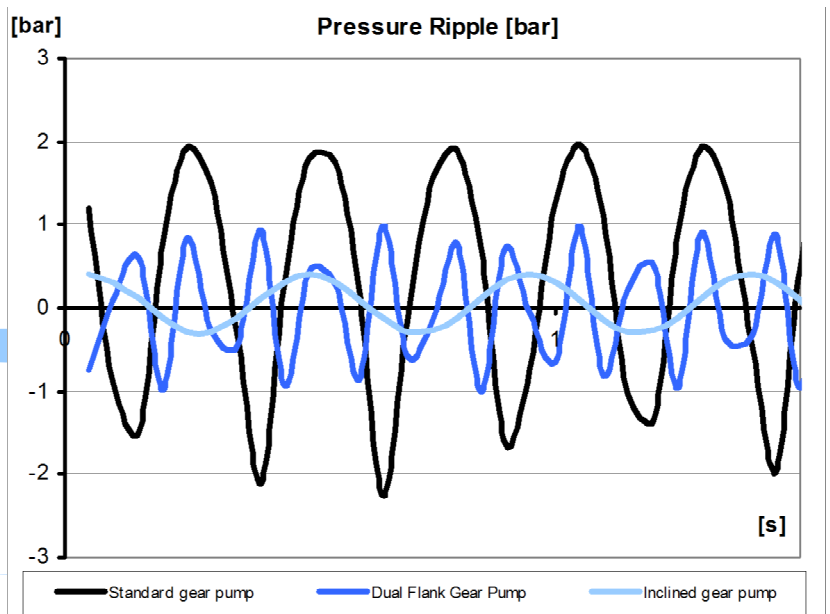

INSTALLATION NOTES

Please strictly follow assembly and use indications given in this catalogue for top performance, longer life and noise of the ELI Marzocchi series. Some general considerations should be made on the hydraulic system, in which the pump must be fitted. Special attention shall be devoted to hydraulic system design and assembly, especially to intake, delivery and return pipes and position of system parts (valves, filters, tanks, heat exchangers and accumulators). Proper safety devices and reliable instruments to avoid fluid turbulence, especially in return pipe to the tank, and prevent air, water and foreign bodies from entering into the system are of major importance. It is also very important to equip the hydraulic system with a proper filtering unit. Before starting the system on a continuous basis, we suggest to adopt some simple precautions: – Check for the direction of rotation of the pump to be consistent with the drive shaft of the prime mover. – Check for the proper alignment of pump shaft and motor shaft: it is necessary that the connection does not induce axial or radial loads. – Protect drive shaft seal during pump painting. Check if contact area between seal ring and shaft is clean: dust could provoke quicker wear and leakage. – Remove all dirt, chips and all foreign bodies from flanges connecting inlet and delivery ports. – Ensure that intake and return pipes are always below fluid level and as far from each other as possible. – Install the pump below head, if possible. – Fill the pump with fluid, and turn it by hand. – At first startup, set pressure limiting valves at min. value possible. – Avoid lower rotation speed than min. allowed with pressure higher than P1. – Do not start the system at low temperatures under load conditions or after long stops (always avoid or limit load starting for pump longer life. Start the system for a few minutes and turn on all components; bleed air off the circuit its proper filling.— Check fluid level in the tank after loading all components.— At last, gradually increase pressure, continuously check fluid and moving parts temperature, check rotation speed until you reach set operating values that shall be within the limits indicated in this catalogue.

CLEANING AND FILTERING THE SYSTEM

It is widely known that most pumps early failures are due to contaminated fluids. The extreme reduction of the tolerances required in the design of the pumps and therefore their operation with minimum clearances, are heavily influenced by a fluid that is not perfectly clean. It is proved that particles circulating in the fluid act as abrasive agents, damaging the surfaces they touch and increasing the quantity of contaminant. For this reason, ensure that system is perfectly clean during startup and keep it clean for the whole operating life. Necessary interventions to check and limit contamination should be performed in a preventive and corrective way. Preventive actions include: proper cleaning of the system during assembly, deburring, eliminating the welding scum and fluid filtering before filling up. Starting contamination level of system fluid should not exceed class 18/15 (ref. ISO 4406). Even fresh fluids might exceed this contamination level; therefore always pre-filter the fluid when filling up or topping up the system. Fit a proper tank; its capacity should be proportional to the volume displaced by the pump in one working minute. Fluid contamination level check and correction during operation can be obtained through filters that retain the particles in the fluid. Two parameters tell which filter is most suitable: absolute filtering power and β filtering ratio.

Low absolute filtering power and high β filtering ratio for small particles help ensuring good filtration. It is then very important to limit not only max dimensions, but also the number of smaller particles that pass through the filter. It goes without saying that with an operating pressure increase and according to the system sophistication degree, filtering should become more and more efficient. The filtering system shall always ensure contamination levels not exceeding the values indicates below.

Pressione	Pressure	< 140 bar	140 ÷ 210 bar	> 210 bar
Classe NAS 1638	NAS 1638 Class	10	9	8
Classe ISO 4406	ISO 4406 Class	19/16	18/15	17/14
Rapporto $\beta_x = 75$	Ratio $\beta_x = 75$	25 – 40 μm	12 – 15 μm	6 – 12 μm

HYDRAULIC FLUIDS

Use specific mineral oil based hydraulic fluids having good anti-wear, anti-foaming (rapid de-aeration), antioxidant, anti-corrosion and lubricating proprieties. Fluids should also comply with DIN 51525 and VDMA 24317 standards and get through 11 stage of FZG test. For the standard models, the temperature of the fluid should be between -10°C and $+80^{\circ}\text{C}$. Fluid kinematic viscosity ranges are the following:

Permessi (previa verifica)	Allowed value (upon verification)	6 ÷ 500 cSt
Raccomandati	Recommended value	10 ÷ 100 cSt
Consentiti all'avviamento	Value allowed at startup	< 2000 cSt

If fluids other than the above mentioned ones are used, please always indicate type of used fluid and operating conditions so that our Sales and Technical Dept. can weigh possible problems on compatibility or useful life of system parts.

INLET PRESSURE

Under standard working conditions, intake pipe pressure is lower than atmospheric pressure. The operating inlet pressure should range between 0.7 and 3 bars (absolute).

INLET AND DELIVERY LINES

Hydraulic system pipes should show no sudden changes of direction, sharp bends and sudden differences in cross-section. They should not be too long or out of proportion. Pipe cross-section should be sized so that fluid velocity does not exceed recommended values. It is advisable to carefully consider the possible diameter reduction of the inlet or outlet pipes fitted on flange fittings. Reference values are the following:

Condotto di aspirazione	Intake line	0.5 ÷ 1.6 m/s
Condotto di mandata	Delivery line	2.0 ÷ 6.0 m/s
Condotto di ritorno	Return line	1.6 ÷ 3.0 m/s

PRESSURE DEFINITION

Product tables show three max pressure levels [P1, P2, P3] to which each pump can be used.

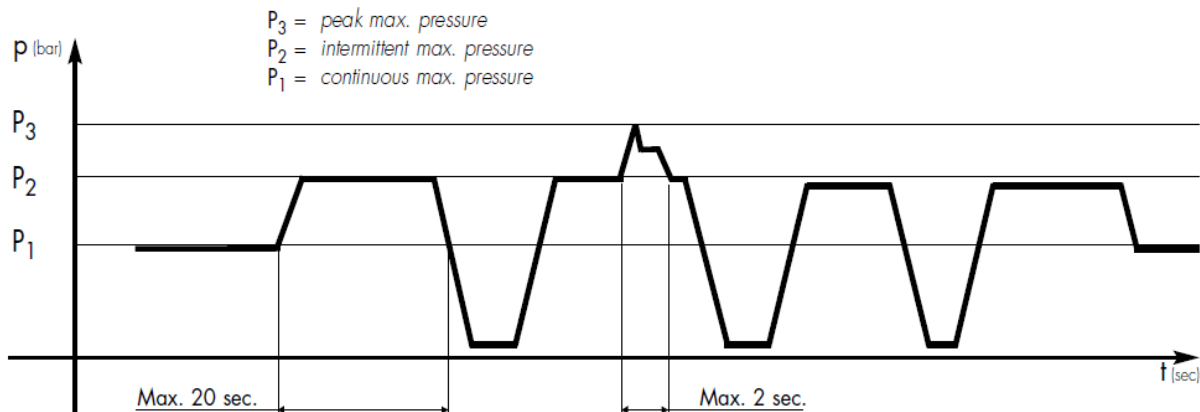

Pressure diagram as a function of time.

DIRECTION OF ROTATION

Marzocchi ELI series pumps are available in either clockwise or counter-clockwise rotation. Direction of rotation of unidirectional pumps is conventionally defined as follows: when standing before the pump with driving shaft up with its projecting end towards the observer, the pump is rotating clockwise in case of right-hand rotation "D"; therefore, delivery side is on the right, whereas intake side is on the left: The contrary will happen with left-handed pumps "S", keeping the same point of view. The ELI pumps can not be modified in order to reverse the work rotation direction.



DRIVE

Connect the pump to the motor using either a flexible coupling (either box or Oldham coupling) so that no radial and/or axial force is transmitted to the pump shaft during rotation, otherwise pump efficiency will dramatically drop due to early wear of inner moving parts. Therefore, coupling must absorb inevitable—even though reduced—misalignment between pump shaft and motor shaft. Box coupling or Oldham coupling should also move axially freely enough (enough for proper contact surface onto pump driving shaft). Furthermore, to avoid early wear of either splined or Oldham couplings, they should be lubricated at regular intervals using specific grease. Please contact our Sales or Technical Depts. for further details.

SEALS

"N" Standard version on NBR the temperature of the fluid should be between -10°C and $+80^{\circ}\text{C}$.

"V" Fluorocarbon version suitable for fluid at high temperatures. Range between -10°C and $+120^{\circ}\text{C}$. In the range between -10°C and $+80^{\circ}\text{C}$ pressures P1, P2 e P3 are possible as per product table; besides that P1 should not be exceeded.

FREQUENTLY USED FORMULAS

Fluid velocity

Calculate the velocity [v] of a fluid in a pipe as follows:

$$v = Q / 6 \times A \text{ [m/s]}$$

Q = flow rate [liter/min]

A = inside area of pipe [cm²]

Delivered flow rate

Calculate flow rate [Q] as follows:

$$Q = V \times n \times \eta_{\text{vol}} \times 10^{-3} \text{ [liter/min]}$$

V = displacement [cm³/rotation]

n = rotation speed [rpm]

η_{vol} = pump volumetric efficiency (take 0.97 as an indicative value for rotation speeds ranging between 1000 and 2000 rpm)

Absorbed torque

Calculate necessary torque [M] of a pump subject to a pressure differential between inlet and delivery as follows:

$$M = (V \times \Delta P) / (62.8 \times \eta_{\text{hm}}) \text{ [Nm]}$$

V = displacement [cm³/rotation]

ΔP = pressure differential [bar]

η_{hm} = hydromechanical efficiency (take 0.80 as indicative value under cold conditions and 0.85 under working conditions)

Absorbed power

Calculate hydraulic power [P] transferred to fluid from a pump subject to pressure differential between inlet and delivery as follows:

$$P = (Q \times \Delta P) / (600 \times \eta_{\text{tot}}) \text{ [kW]}$$

Q = flow rate [liter/min]

ΔP = pressure differential [bar]

η_{tot} = total pump efficiency ($\eta_{\text{hm}} \times \eta_{\text{vol}}$)

Values for η_{vol} and η_{hm} (and consequently η_{tot}) depend on pressure differential between inlet and delivery, rotation speed, fluid features (temperature and viscosity) and filtering degree. Call our Sales and Technical Dept. for further details on efficiency. The proper values for flow rate, torque and power absorbed according to pressure differential , rotation speed and set test conditions, can be found on the pages dedicated to the performance curves.

How to order

ELI	TYPE	ROTATION	DISPL.	SHAFT	PORTS	SEALS
	3	D - CW	20.4	T0	A	N
	3A	S - CCW	21.6	C0	FA**	V
			26.3	C1		
			33.3	C3		
			39.1	S1		
			43.2	S2		
			52.0			
			60.8			
			64.3			
			70.7			
			78.3			
			87.1			

Pump standard types:

- 3 = european flange + shaft T0 + ports A + standard seals
 3A = flange A + shaft C1 + ports A + standard seals

Examples:

- ELI3-D-33.3-T0-A-N = clockwise rotation, 33.3 cm³/rev, european flange, 1:8 tapered shaft, flanged ports A type, standard seals.
 ELI3A-D-33.3-S1-A-N = clockwise rotation, 33.3 cm³/rev, SAE flange, splined shaft S1, flanged ports A type, standard seals.
 ELI3A-D-33.3-C1-FA-N = clockwise rotation, 33.3 cm³/rev, SAE flange, cylindrical shaft C1, threaded ports FA**, standard seals.

The product data sheets show our standard model types. The synoptic tables for flanges, shafts and ports show all the possible configurations. For further details about the availability of each configuration please contact our Sales and Technical Dept.

* Value based on ISO4412 test procedure

** With thread ports on outlet side, a reduction of body fatigue strength may occur if the pump is working at elevated and intermittent pressures. For further details please contact our Sales and Technical Dept. we suggest to provide application specification through our PID form.

ELI3

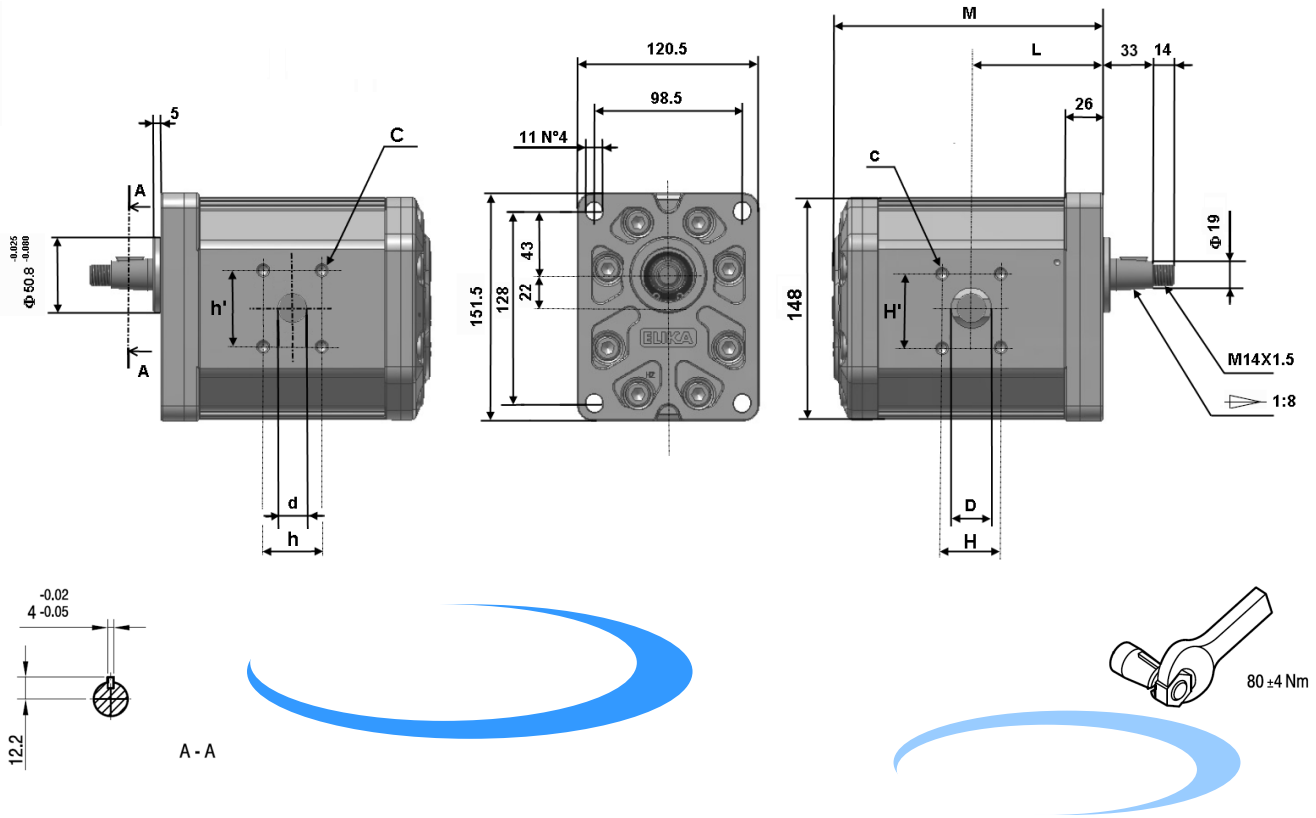
Outlet
Inlet

Pump Type	Displ. [cm ³ /rev]	Flow at 1500 rpm [l/min]	Operating pressures			Rotation speed		Noise at 1500 rpm *		Dimensions					
			P1 Max cont. [bar]	P2 Max intermit. [bar]	P3 Max peak [bar]	Minimum speed [rpm]	Maximum speed [rpm]	On recirc. [dBA]	at P1 [dBA]	L [mm]	M [mm]	D [mm]	H / H' [mm]	d [mm]	h/h' [mm]
ELI3-20.4	20.4	30.7	280	295	310	300	3500	49	59	62.8	129.5	25	26.2 / 52.4	19	22.2 / 47.6
ELI3-21.6	21.6	32.4	280	295	310	300	3500	49	59	63.3	130.5	25	26.2 / 52.4	19	22.2 / 47.6
ELI3-26.3	26.3	39.4	280	295	310	300	3500	49	59	65.3	134.5	25	26.2 / 52.4	19	22.2 / 47.6
ELI3-33.3	33.3	50.0	270	285	300	300	3500	50	60	68.3	140.5	31.5	30.2 / 58.7	25	26.2 / 52.4
ELI3-39.1	39.1	58.7	260	275	290	300	3500	50	60	70.8	145.5	31.5	30.2 / 58.7	25	26.2 / 52.4
ELI3-43.2	43.2	64.8	250	265	280	200	3500	51	61	72.5	149.0	31.5	30.2 / 58.7	25	26.2 / 52.4
ELI3-52.0	52.0	78.0	230	245	260	200	3500	51	61	76.3	156.5	31.5	30.2 / 58.7	31.5	30.2 / 58.7
ELI3-60.8	60.8	91.1	210	225	240	200	3300	51	62	80.0	164.0	31.5	30.2 / 58.7	31.5	30.2 / 58.7
ELI3-64.3	64.3	96.4	210	225	240	200	3200	51	62	81.5	167.0	31.5	30.2 / 58.7	31.5	30.2 / 58.7
ELI3-70.7	70.7	106.0	200	215	230	200	2900	52	63	84.3	172.5	38	69.9 / 35.7	31.5	30.2 / 58.7
ELI3-78.3	78.3	117.4	180	195	210	200	2600	52	63	87.5	179.0	38	69.9 / 35.7	31.5	30.2 / 58.7
ELI3-87.1	87.1	130.6	160	175	190	200	2400	52	63	91.3	186.5	38	69.9 / 35.7	31.5	30.2 / 58.7

Accessories supplied with the standard pump: woodruff key (code 522058), M14x1.5 hexagonal nut (code 523017), washer (code 523006). Standard ports: M10, M12 threads depth 20 mm. Please strictly follow assembly and use indications given in this catalogue for top performance and longer life of the ELI Marzocchi series. It is also very important to equip the hydraulic system with a proper filtering unit.

ELI3A

Inlet

Outlet

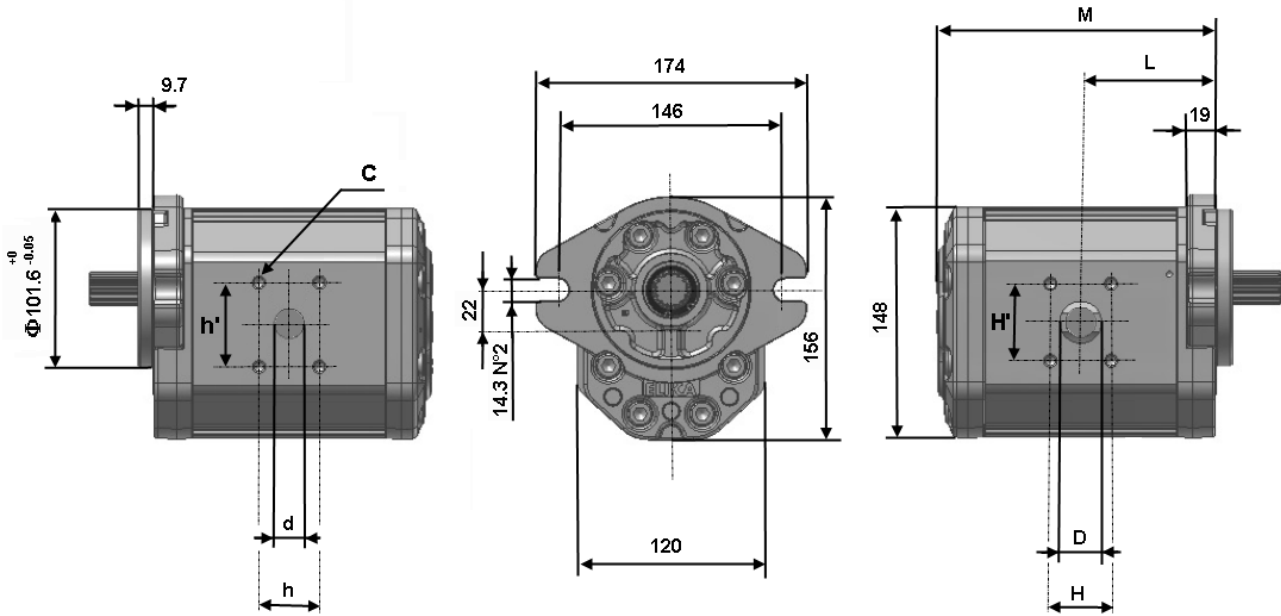

Pump Type	Displ. [cm ³ /rev]	Flow at 1500 rpm [l/min]	Operating pressures			Rotation speed		Noise at 1500 rpm *		Dimensions					
			P1 Max cont. [bar]	P2 Max intermit. [bar]	P3 Max peak [bar]	Minimum speed [rpm]	Maximum speed [rpm]	On recirc. [dBA]	at P1 [dBA]	L [mm]	M [mm]	D [mm]	H / H' [mm]	d [mm]	h / h' [mm]
ELI3A-20.4	20.4	30.7	280	295	310	300	3500	49	59	62.8	129.5	25	26.2 / 52.4	19	22.2 / 47.6
ELI3A-21.6	21.6	32.4	280	295	310	300	3500	49	59	63.3	130.5	25	26.2 / 52.4	19	22.2 / 47.6
ELI3A-26.3	26.3	39.4	280	295	310	300	3500	49	59	65.3	134.5	25	26.2 / 52.4	19	22.2 / 47.6
ELI3A-33.3	33.3	50.0	270	285	300	300	3500	50	60	68.3	140.5	31.5	30.2 / 58.7	25	26.2 / 52.4
ELI3A-39.1	39.1	58.7	260	275	290	300	3500	50	60	70.8	145.5	31.5	30.2 / 58.7	25	26.2 / 52.4
ELI3A-43.2	43.2	64.8	250	265	280	200	3500	51	61	72.5	149.0	31.5	30.2 / 58.7	25	26.2 / 52.4
ELI3A-52.0	52.0	78.0	230	245	260	200	3500	51	61	76.3	156.5	31.5	30.2 / 58.7	31.5	30.2 / 58.7
ELI3A-60.8	60.8	91.1	210	225	240	200	3300	51	62	80.0	164.0	31.5	30.2 / 58.7	31.5	30.2 / 58.7
ELI3A-64.3	64.3	96.4	210	225	240	200	3200	51	62	81.5	167.0	31.5	30.2 / 58.7	31.5	30.2 / 58.7
ELI3A-70.7	70.7	106.0	200	215	230	200	2900	52	63	84.3	172.5	38	69.9 / 35.7	31.5	30.2 / 58.7
ELI3A-78.3	78.3	117.4	180	195	210	200	2600	52	63	87.5	179.0	38	69.9 / 35.7	31.5	30.2 / 58.7
ELI3A-87.1	87.1	130.6	160	175	190	200	2400	52	63	91.3	186.5	38	69.9 / 35.7	31.5	30.2 / 58.7

Accessories supplied with the standard pump: woodruff key (code 522058), M14x1.5 hexagonal nut (code 523017), washer (code 523006). Standard ports: M10, M12 threads depth 20 mm. Please strictly follow assembly and use indications given in this catalogue for top performance and longer life of the ELI Marzocchi series. It is also very important to equip the hydraulic system with a proper filtering unit.

FLANGE / FLANGES

ALBERI / SHAFTS

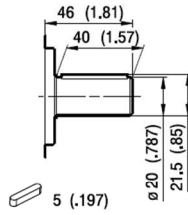
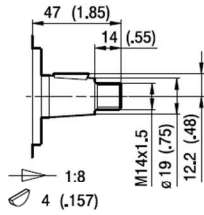
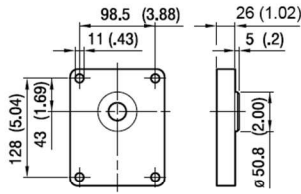

T0

Coppia Max
Max Torque 280 Nm

C0

Coppia Max
Max Torque 265 Nm

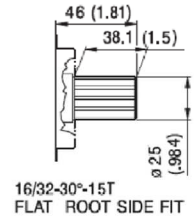
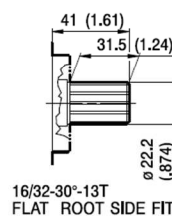
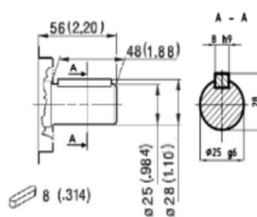
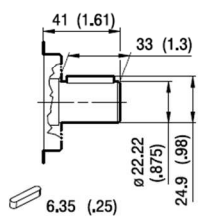
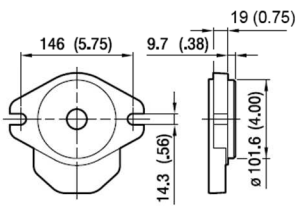

C1

Coppia Max
Max Torque 295 Nm

C3

Coppia Max
Max Torque 380 Nm

S1

Coppia Max
Max Torque 405 Nm

S2

Coppia Max
Max Torque 660 Nm

PORTE / PORTS

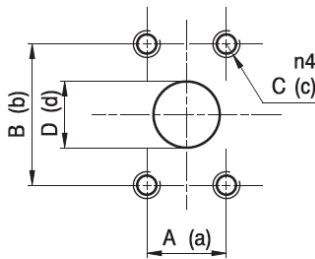

A

TYPE	INLET			OUTLET		
	D	A / B	C	d	a / b	c
ELI3..20.4 / 26.3	25	26.2 / 52.4	M10	19	22.2 / 47.6	M10
ELI3..33.3 / 43.2	31.5	30.2 / 58.7	M10	25	26.2 / 52.4	M10
ELI3..52.0 / 64.3	31.5	30.2 / 58.7	M10	31.5	30.2 / 58.7	M10
ELI3..70.7 / 87.1	38	69.9 / 35.7	M12	31.5	30.2 / 58.7	M10

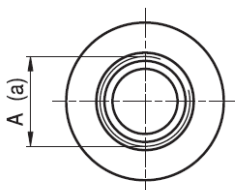

STANDARD SAE J1926/1
ONLY FOR INLET PORTS

FA

***** With thread ports a reduction of body fatigue strength may occur if the pump is working at elevated and intermittent pressures. For further details please contact our Sales and Technical Dept. we suggest to provide application specification through our PID form.

ELI3-20.4

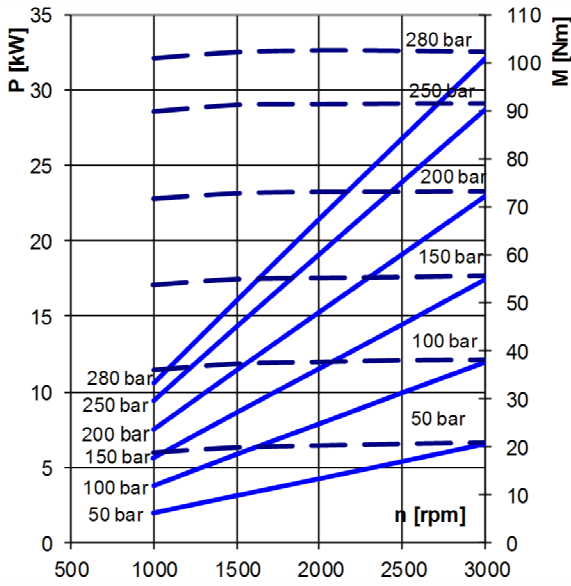

ELI3-21.6

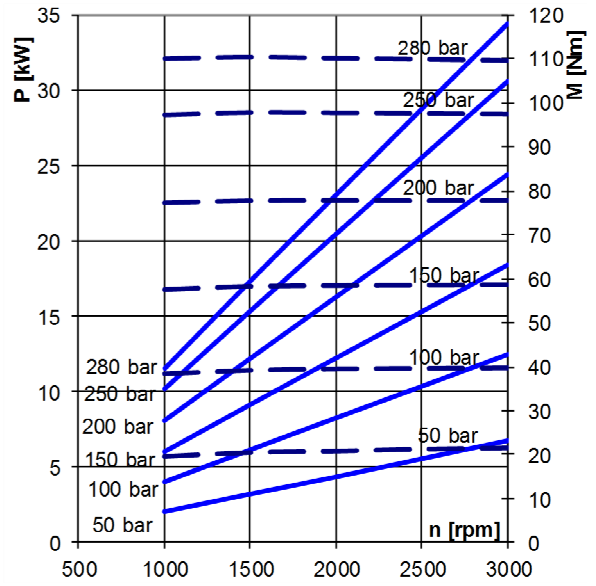

ELI3-26.3

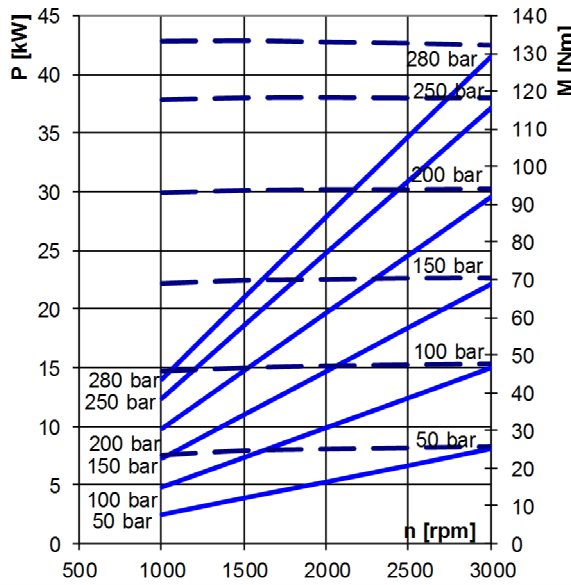

ELI3-33.3

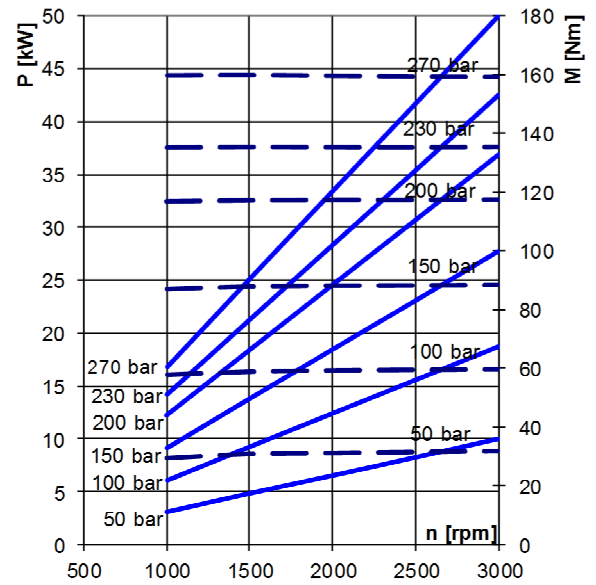

ELI3-39.1

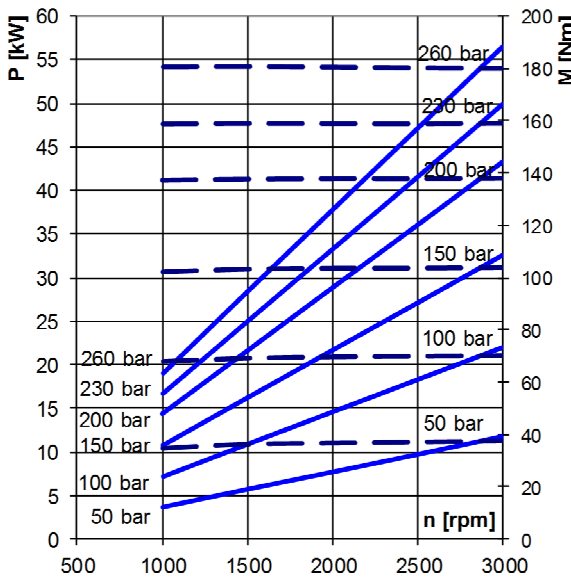

ELI3-43.2

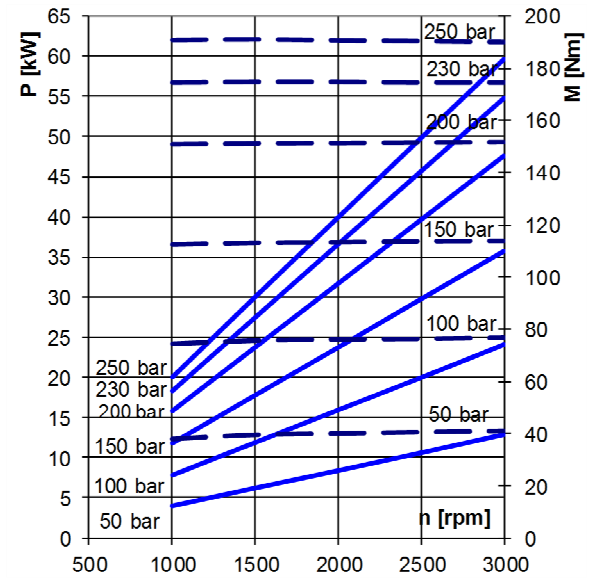

ELI3-52.0

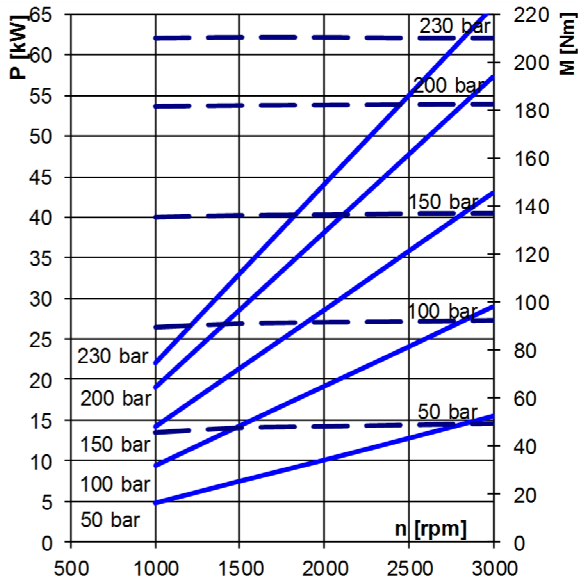

ELI3-60.8

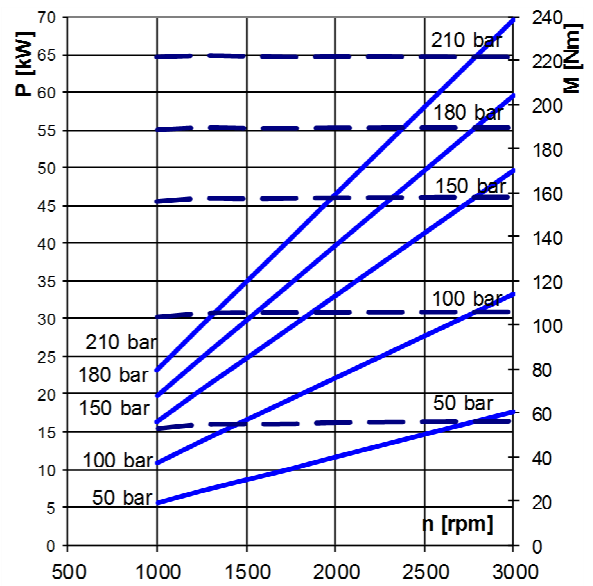

ELI3-64.3

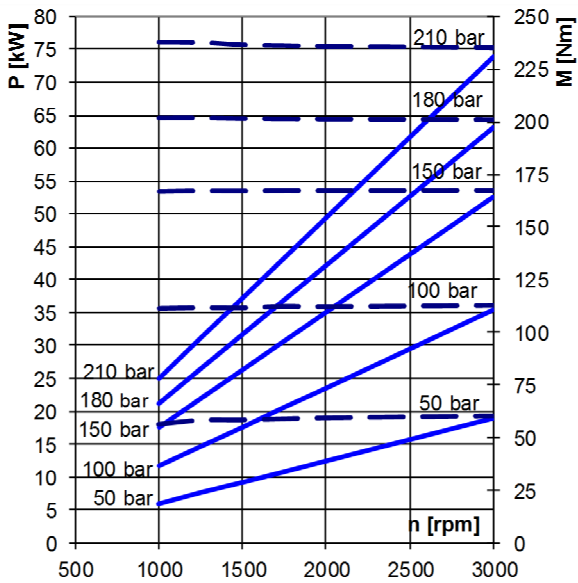

ELI3-70.7

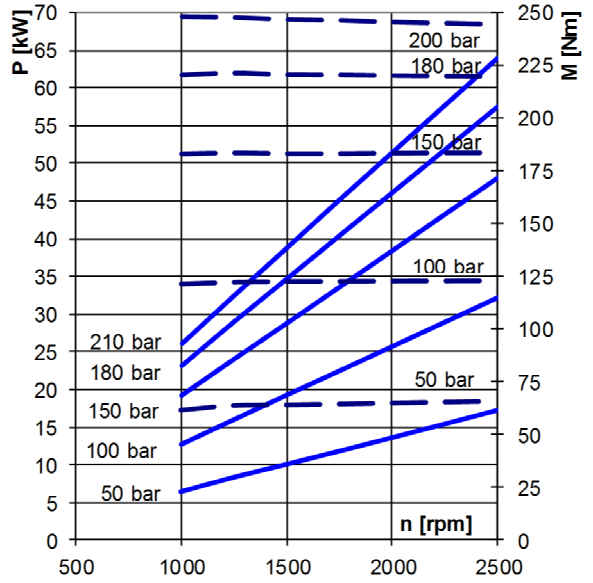

ELI3-78.3

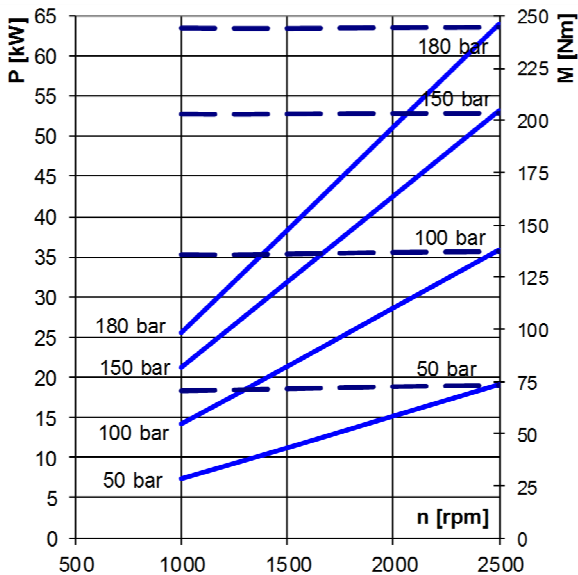

ELI3-87.1

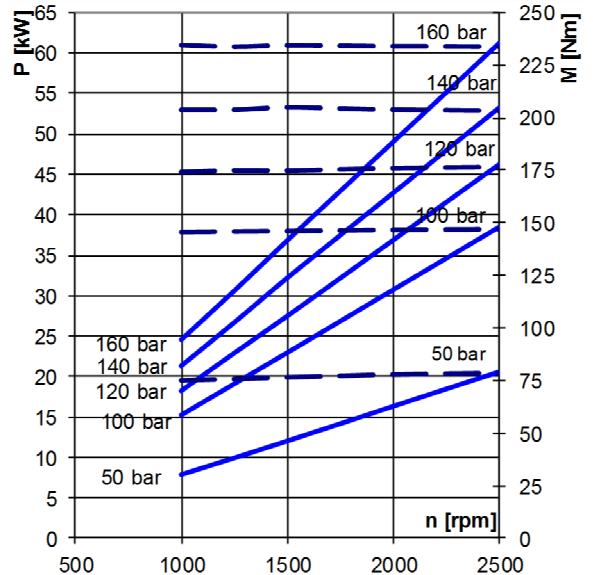

ELI3-20.4 / ELI3-21.6

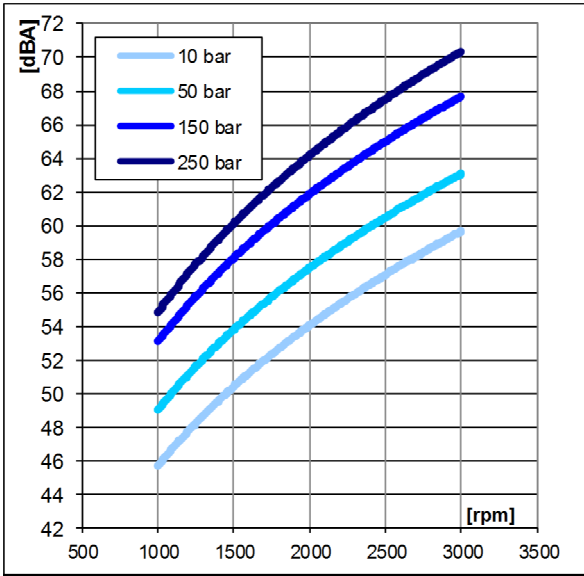

ELI3-26.3 / ELI3-33.3

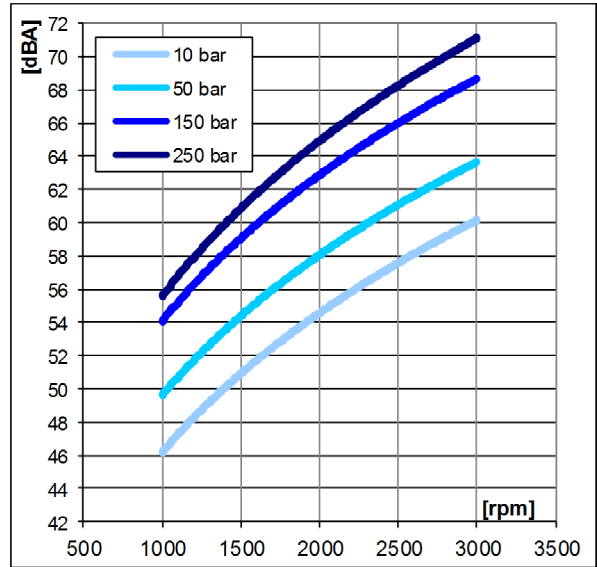

ELI3-39.1 / ELI3-43.2

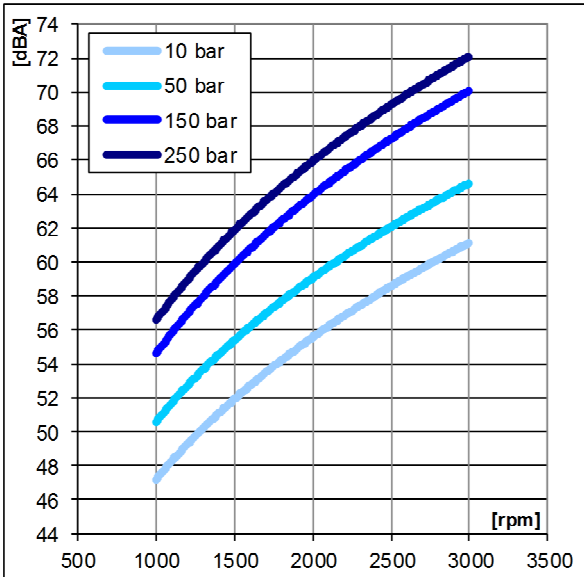

ELI3-52.0 / ELI3-60.8

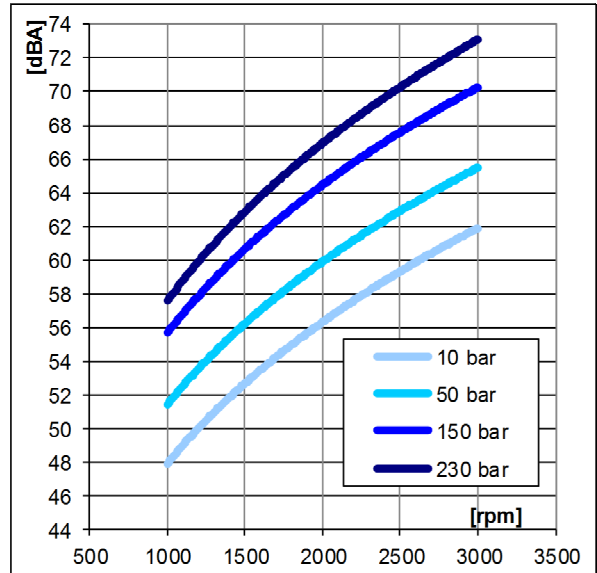

ELI3-64.3 / ELI3-70.7

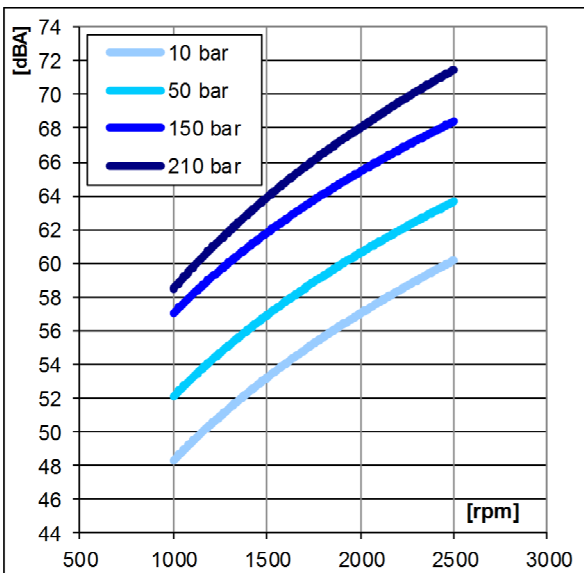

ELI3-78.3 / ELI3-87.1

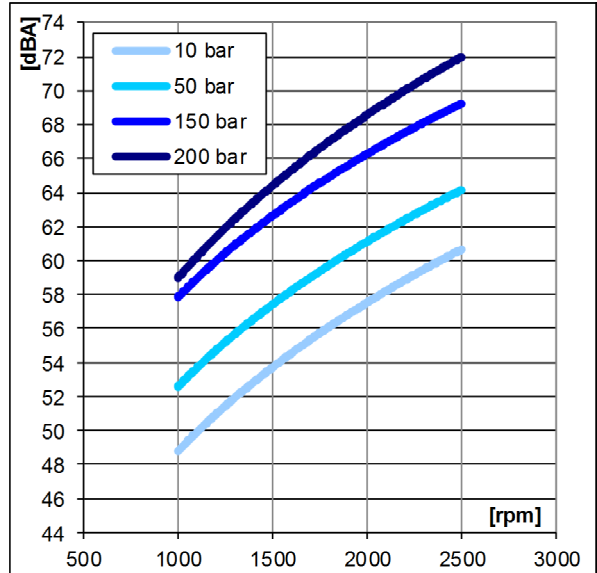



ELIKA[®]
by **MARZOCCHI**



YEAR 1961 – First pump by Marzocchi

YEAR 2011 – First ELIKA by Marzocchi



Marzocchi Pompe SpA

Via 63° Brigata Bolero 15
40033 Casalecchio di Reno
Bologna – Italy
Tel.: +39 051 6137511
Fax: +39 051 592083
E-mail: info@marzocchipompe.com
web site: www.marzocchipompe.com

Marzocchi Pompe declines all responsibility for any errors this catalogue may contain. Apart from general specifications and recommendations concerning installation and conditions of use, the content of this catalogue is provided for information purposes and Marzocchi Pompe SpA reserves all rights to make any changes to the technical features of its products at any time and without prior warning. In the event the products will be used as part of specific applications or you have any doubts about whether or not the products can be used for one or more special applications, please feel free to contact our Technical-Sales service at Marzocchi Spa.



Marzocchi Pumps USA

905 ALBION
SCHAUMBURG, IL 60193
tl office 847-923-9910
tl toll free 800-924-5404
fax 847-923-9937
E-mail: pumps@marzocchipumpsusa.com
web site: www.marzocchipumpsusa.com